

REACH & RoHS
COMPLIANT

REV.	ECN / DESCRIPTION	BY	DATE
A0	NEW	ZG.HU	2018.06.01
A1	Splice type changed to splice+ one - body assembly product	ZG.HU	2023.03.07

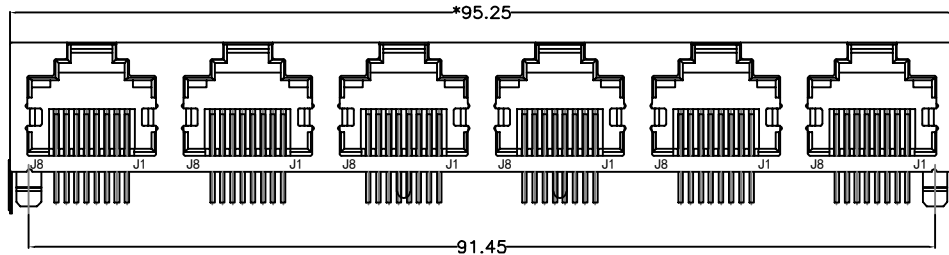

FRONT VIEW

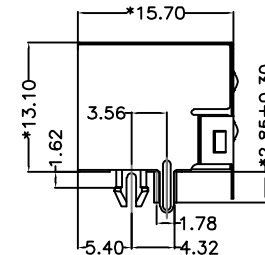

RIGHT SIDE VIEW

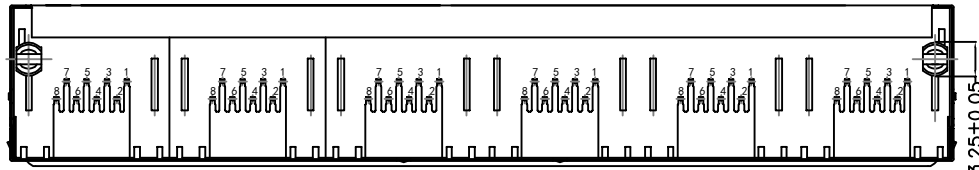

BOTTOM VIEW

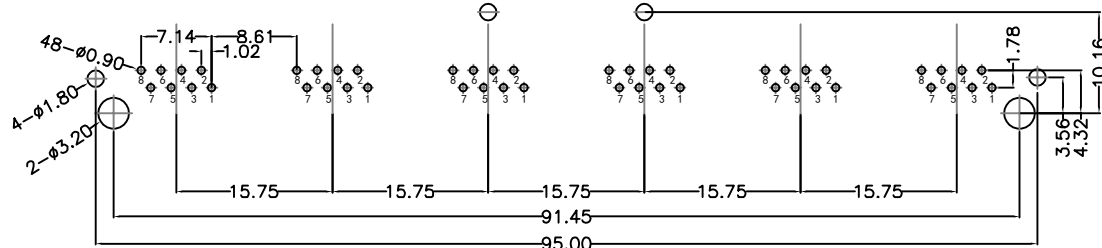

RECOMMENDED PCB LAYOUT
VIEWED FROM COMPONENT SIDE

MATERIAL:
 HOUSING: PBT,UL94V-0,BLACK.
 TERMINAL: PHOSPHOR BRONZE Ø=0.46MM.
 G/FU" GOLD PLATING ON CONTACT AREA.
 SHIELD: C2680,T=0.20MM,20 MIN NICKEL PLATING ON ALL AREA.

MACHANICAL:
 DURABILITY: 750 CYCLES MIN,12.5MM/MINUTE.
 INSERTION FORCE: 2.2KG.F MAX.
 RETENTION STRENGTH : 7.7KG.F BETWEEN JACK AND PLUG.
 OPERATING TEMPERATURE: -40°C~+85°C.
 STORAGE TEMPERATURE: -40°C~+85°C.
 ALL CRITICAL DIMENSIONS WITH "*"

ELECTRICAL:
 VOLTAGE: 125 VOLTS AC.
 CURRENT RATING : 1.5AMP.
 DIELECTRIC STRENGTH: 1000 VAC RMS 50HZ OR 60HZ,1MIN.
 INSULATION RESISTANCE: 500 MEGA OHMS MIN. INITIAL
 AFTER 500V DC FOR 1 MINUTE.
 CONTACT RESISTANCE: SINGLE TERMINAL 30 MILLIOHMS MAX.
 INITIAL 50 MILLIOHMS MAX. AFTER
 DURABILITY TEST.

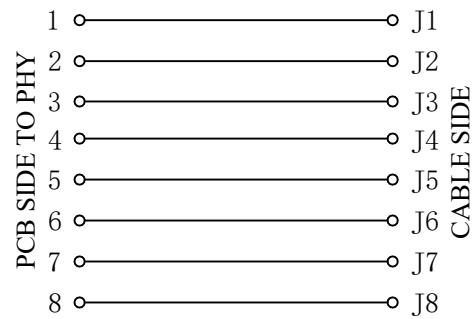

DGKYD

东莞市科优达电子科技有限公司
Dong Guan Ke You Da Electronic Tech.Co.,Ltd

ADD: No.1 LiHe Street,LiHeng Village,Qingxi town, DongGuan City,GuangDong Province
Tel:+86-0769-87334608; Fax:+86-0769-87847129 WWW.DGKYD.COM

TITLE: 56带屏蔽无灯 1X6 8P8C	SIZE A4	UNITS MM[INCH]	GENERAL TOLERANCES UNLESS SPECIFIED		APPROVED BY: JP.Gong				
			PART NO.: DGKYD561688GWA1D9Y1022	SACLE 1:1		REV A1	x±0.35	x°±3.0°	CHECKED BY: TW.Xu
							.x±0.30	.x°±2.0°	
							.xx±0.25	.xx°±1.5°	
REMARK:	SHEET 1/2		.xxx±0.10	.xxx°±1.0°	DESIGND BY: ZG.Hu				

REACH & RoHS
COMPLIANT

Suggested Panel Opening:

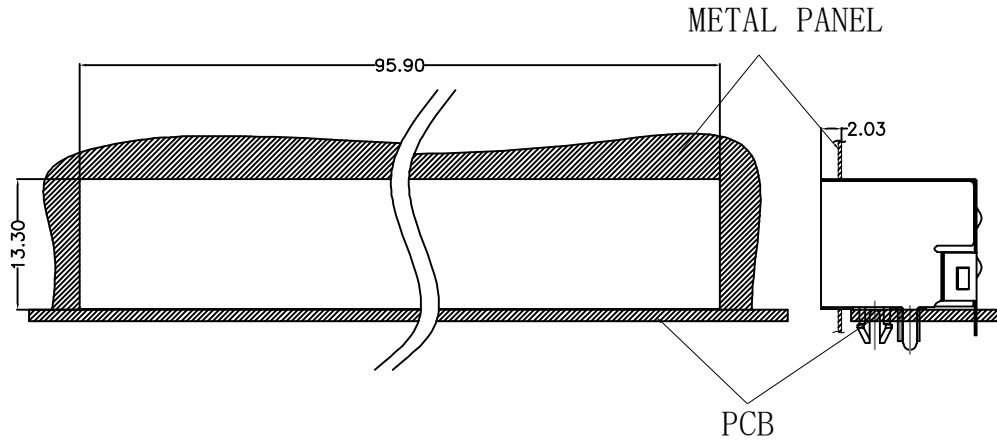

UNIT: mm / inch
Tolerances: $\pm 0.10 / 0.004$

REV.	ECN / DESCRIPTION	BY	DATE
A0	NEW	ZG.HU	2018.06.01
A1	Splice type changed to splice+ one - body assembly product	ZG.HU	2023.03.07

Keep-Out Area (Component Side View):

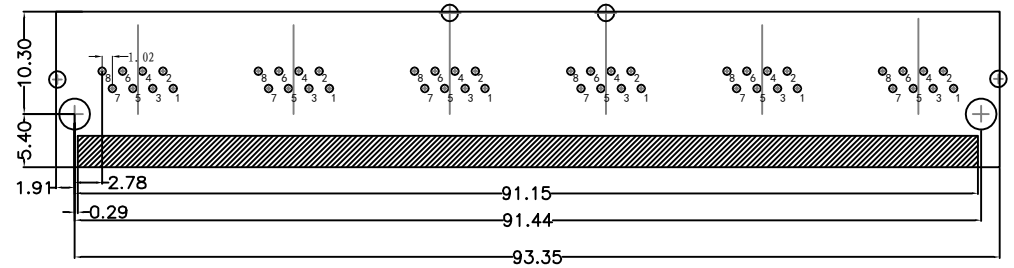

Plug In Side

UNIT: mm / inch
Tolerances: $\pm 0.10 / 0.004$

DGKYD

东莞市科优达电子科技有限公司
Dong Guan Ke You Da Electronic Tech.Co.,Ltd

ADD: No.1 LiHe Street, LiHeng Village, Qingxi town, DongGuan City, GuangDong Province
Tel: +86-0769-87334608; Fax: +86-0769-87847129 WWW.DGKYD.COM

TITLE:
56带屏蔽无灯 1X6 8P8C

PART NO.:
DGKYD561688GWA1D9Y1022

REMARK:

SIZE
A4

SACLE
1:1

SHEET
2/2

UNITS
MM[INCH]

REV
A1

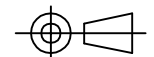

GENERAL TOLERANCES
UNLESS SPECIFIED

$x \pm 0.35$	$x^\circ \pm 3.0^\circ$
$.x \pm 0.30$	$.x^\circ \pm 2.0^\circ$
$.xx \pm 0.25$	$.xx^\circ \pm 1.5^\circ$
$.xxx \pm 0.10$	$.xxx^\circ \pm 1.0^\circ$

APPROVED BY:
JP.Gong

CHECKED BY:
TW.Xu

DESIGND BY:
ZG.Hu